

DOI 10 kit for water temperature



Product and Documentation Changes

dol-sensors reserves the right to change this document and the product herein described without further notice. In case of doubt, please contact dol-sensors.

The date of change appears from the front and back pages.

Note

- All rights belong to dol-sensors. No part of this manual may be reproduced in any manner whatsoever without the expressed written permission of dol-sensors in each case.
- All reasonable efforts have been made to ensure the accuracy of the information contained in this manual. Should any mistakes or imprecise information occur in spite of this, dol-sensors would appreciate being notified thereof.
- Irrespective of the above, dol-sensors shall not accept any liability with regard to loss or damage caused or alleged to be caused by reliance on any information contained herein.
- Copyright by dol-sensors.

1 Product description

DOL 10 kit is used to measure the water temperature in the water line in connection with water flushing.

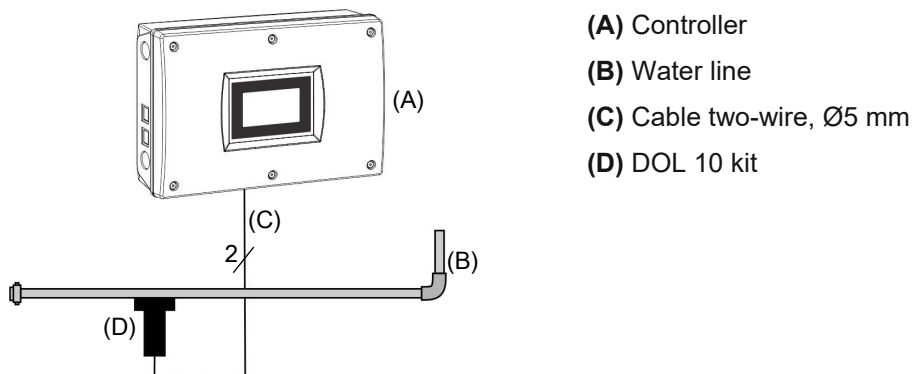





DOL 10 kit for water temperature contains:

- 1 DOL 10 temperature sensor with five m. cable and rubber case.
- 1 6.5 mm drill bit
- 1 tube of silicone glue
- 2 stips
- 1 Technical User Guide

2 Mounting guide

2.1 Recommended tools

Below follows a list of tools recommended for installation of the DOL 10 kit.

Item	Description
	Tape measure
	Cordless drill
	Needle-nose pliers
	Side cutter

2.2 Mounting

Must be mounted approx. 2/3 from the start of the middle water line.

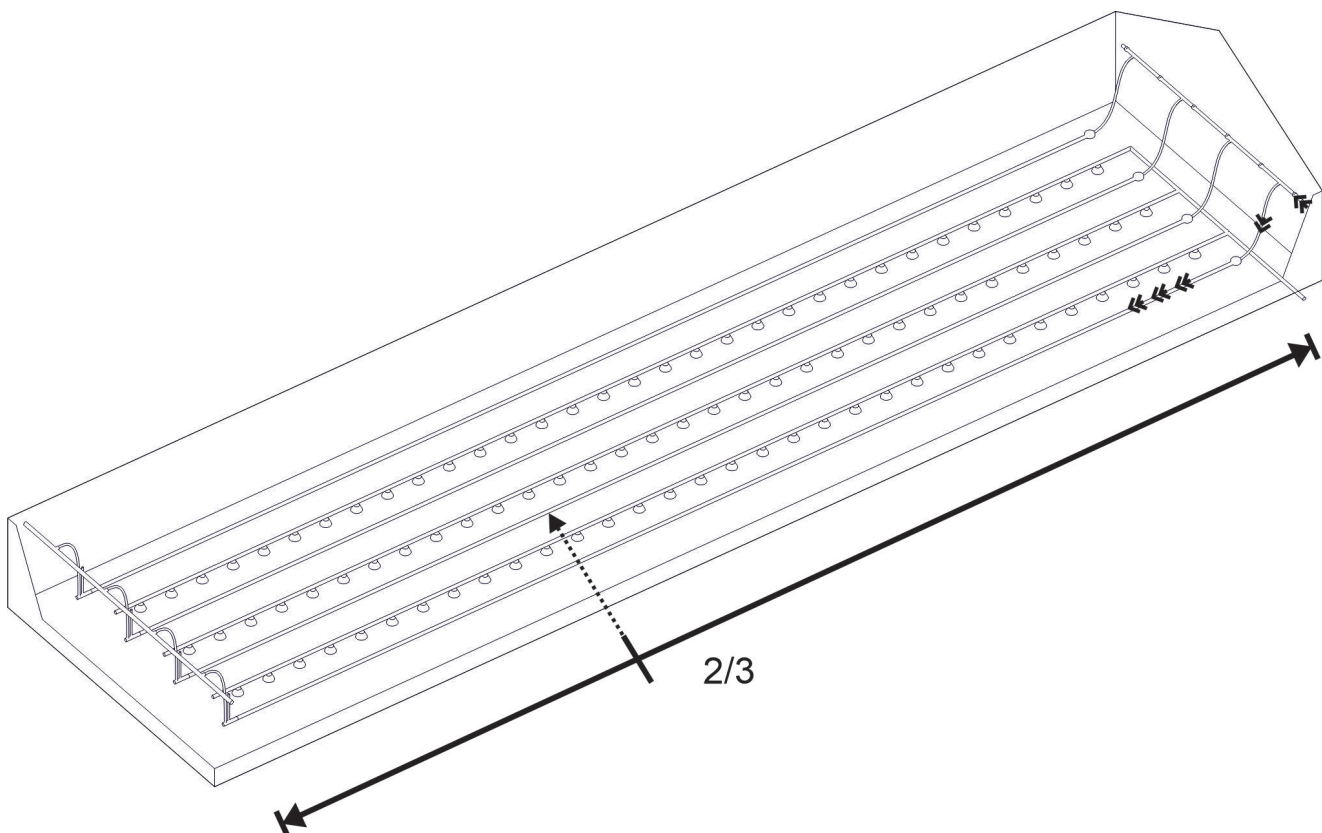



Drill a 6.5 mm hole in the centre of the water line.

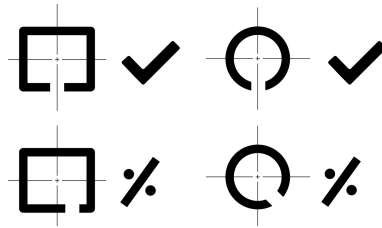

Mount the two strips loosely on each side of the hole in the water line.



Apply glue to the sensor body and pull the sensor into the rubber case by pulling the cable.

NB! NOTE! While pulling, rotate the sensor to distribute the silicone glue in the entire case.

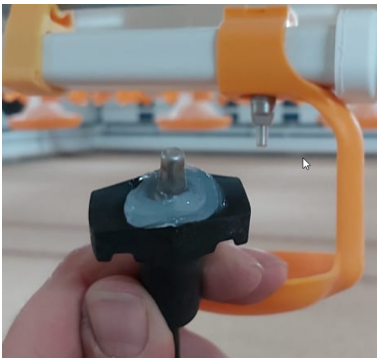

Apply silicone glue to the top of the rubber case. It is important to fill the hole around the sensor with glue.



Insert DOL 10 in the pre-drilled hole and push the rubber case toward the water line.

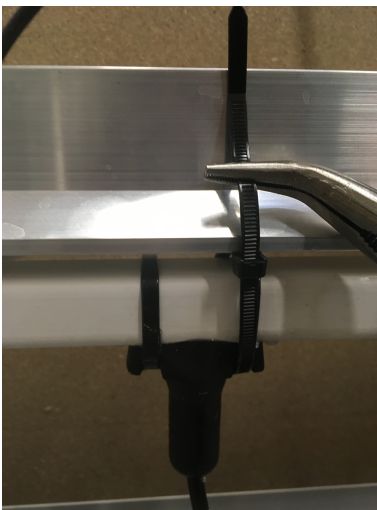

Place the two strips in the two grooves on the rubber case. Tighten the strips to make sure the case fits closely to the water line.



Cut off the strips and fasten the DOL 10 cable to the installation and connect it to the controller as specified in Circuit Diagram [▶ 6].

3 Installation



Installation, servicing and troubleshooting of all electrical equipment must be carried out by qualified personnel in compliance with the applicable national and international standard EN 60204-1 and any other EU standards that are applicable in Europe.

The installation of a power supply isolator is required for each motor and power supply to facilitate voltage-free work on the electrical equipment. The power supply isolator is not included.

3.1 Circuit Diagram

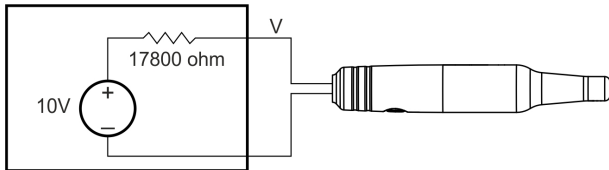

Figure 1: DOL 10.

°C	kΩ*	V	°C	kΩ*	V	°C	kΩ*	V
-40	82.50	8.08	13	22.03	5.44	33	12.24	4.03
-35	76.84	7.96	14	21.36	5.37	34	11.91	3.97
-30	70.60	7.83	15	20.71	5.29	35	11.60	3.91
-25	63.97	7.68	16	20.09	5.22	36	11.30	3.85
-20	57.18	7.49	17	19.48	5.15	37	11.01	3.79
-15	50.50	7.26	18	18.90	5.07	38	10.72	3.73
-10	44.12	7.00	19	18.33	5.00	39	10.45	3.67
-5	38.22	6.70	20	17.79	4.93	40	10.1	3.61
0	32.1	6.37	21	17.26	4.85	41	9.94	3.55
1	31.92	6.30	22	16.76	4.78	42	9.70	3.50
2	30.96	6.23	23	16.27	4.71	43	9.47	3.44
3	30.02	6.16	24	15.79	4.64	44	9.24	3.39
4	29.11	6.09	25	15.34	4.57	45	9.03	3.34
5	28.23	6.02	26	14.90	4.50	46	8.82	3.29
7	26.53	5.88	27	14.48	4.43	47	8.62	3.24
8	25.72	5.81	28	14.07	4.36	48	8.43	3.19
9	24.94	5.73	29	13.68	4.30	49	8.24	3.14
10	24.17	5.66	30	13.30	4.23	50	8.06	3.09
11	23.44	5.59	31	12.93	4.16	55	7.26	2.87
12	22.72	5.51	32	12.58	4.10	60	6.59	2.68

Table 1: Sensor characteristics. *Zero power measurement

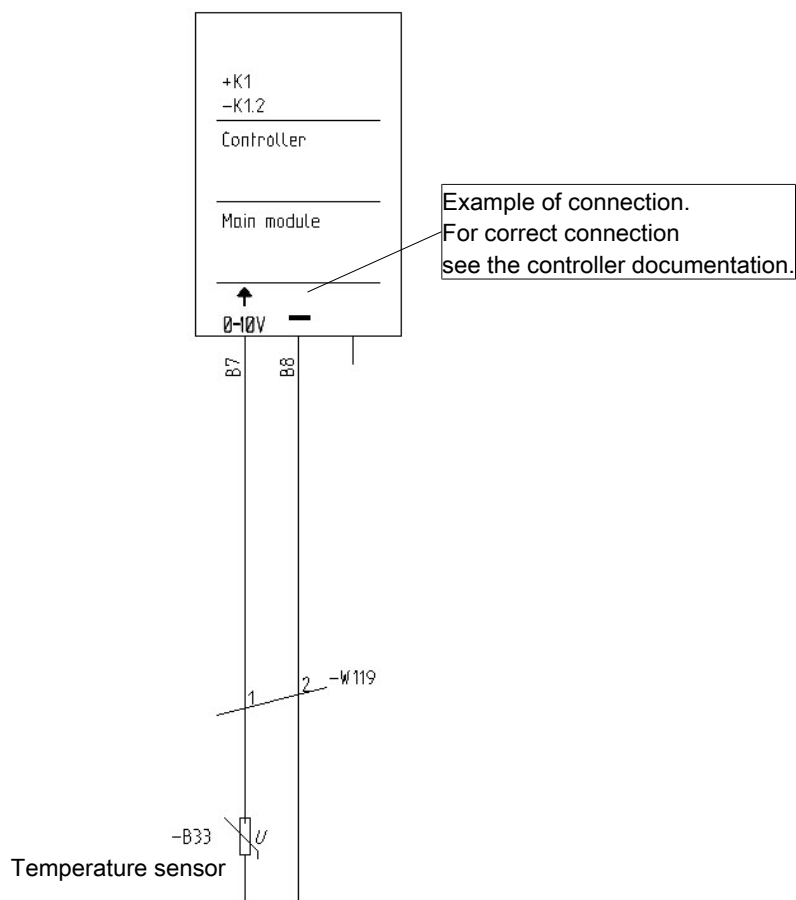

Figure 2: Example of connection.

4 Maintenance

Clean product with:

- A cloth that has been wrung out almost dry in water
- Cold water high-pressure cleaning

Avoid using:

- High-pressure cleaning with hot water
- Solvents
- Corrosive/caustic agents

5 Technical data

Electrical		
Measuring range	°C	-40 to +60
Accuracy	°C	±0.5
Time constant	T ₆₃	< 90 sec.
Mechanical		
Material		TECHNOMELT® PA 6208 BLACK Polyamide, rubber
Cable		Two-wire, 5 m, Ø 5 mm
Max. cable length at 0.75 mm ²	m	100
Max. cable length at 1.5 mm ²	m	200
Environment		
Ambient temperature	°C	-40 to +60
Protection class	IP	66
Shipment		
Dimensions when packed H x W x D	mm	230 x 320 x 35
Weight	g	266
Shipping weight	g	289