



PORTABLE DATA LOGGING SYSTEMS

for Professionals



ADVANCED MEASURING
INSTRUMENTS

MultiCon MultiLog



Measure,
Control and Log Data



Introduction

SIMEX is a Polish manufacturer and supplier of industrial automation equipment. The company has been in the market for nearly 30 years and offers services provided by a team of young and qualified professionals, both designers and programmers, as well as sales representatives.

We specialise in the production of devices from the following categories: counters, indicators, controllers while concentrating on data recorders. In the offer you will find two families of high quality products for data recording: MultiCon and a series for the less advanced processes - MultiLog. Both devices are designed for stationary measurements.

What's new is the portable case for these products, which allows transporting them from place to place. This is a significant advantage, because stationary recorders gain features of portable recorders and at the same time retain the capabilities for advanced measurement and recording of the tested media. In addition, the sealed case made by PELI™ protects the devices from damage.

Applications

- Recording the operating parameters in water and sewage pumping stations
- Recording the operating parameters in heat chambers and heat exchange units
- Pressure control of hydrophore stations
- Recording changes in river levels

Mine



Pump station



Military



Water treatment plant



Extreme conditions



Hydrophore station



Heat exchange unit



Sewage treatment plant

Portable case - the advantages

Protection of electronic equipment and valuable recorded data is a growing concern. This is particularly important in non-stationary solutions, when measuring instruments are mounted in portable, sealed transport cases, which are the only barrier against the harsh environmental conditions. Therefore, this case must meet a number of requirements guaranteeing the safety of the devices installed in it, and hence the reliability of this type of data recorders. In the sets offered by our company we use PELI™ cases, which is a proven and reliable solution in the transport and storage of sensitive measuring instruments for professionals.

Heavy duty „fins“ are engineered to protect latch and hinge areas.



The double-step latches are smart and make the PELI™ case easier to open.



Technological holes allow for lock or seal set up to increase safety in the event of data theft attempts.



The neoprene **o-ring** keeps the case totally watertight.



Big-fold down and rubberized **handles**.



Stainless steel pins are used in hinges, latches and handles to prevent corrosion.



Automatic pressure equalization valve releases air from the interior while keeping water molecules out, ensuring IP 67 protection class.



Twin-ribbed top surface.

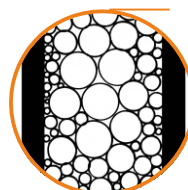

Ultra High Impact Copolymer Polypropylene is extremely strong and flexible against external impacts.



Extra thick **5,3 mm wall construction** provides significantly greater strength to weight ratio over conventional injection moulding.

MultiCon Wn!Con

P130-CMC-99

P130-CMC-141

- up to 23 input/output/communication connectors
- colour display with touchscreen, TFT 3.5" or 5.7"
- RS-485 or Ethernet communication
- tight IP 67 case

MultiCon in a **P130** portable case is a combination of a multichannel controller / data recorder with a sealed waterproof and dustproof housing. This combination gives you the ability to safely perform measurements and record data in particularly demanding and difficult applications, for example, in field conditions with high dust, high humidity or high risk of flooding the device.



The main advantages:

- USB Host port for retrieving data,
- waterproof and dustproof housing, designed to work in conditions of high humidity, high temperature jumps, dust, pressure differences, etc.
- free recording software.

Portable version of **MultiCon** line data recorder works

wherever there is no need or possibility to install stationary devices. Portable case is equipped with all necessary connectors with IP 67 protection degree for connection of sensors, allowing for autonomous operation of the recorder under harsh environmental conditions. By equipping the case with communication interfaces: Ethernet and/or RS-485, the **MultiCon** can provide measurement data to a PC or a host system.

SET CONTENTS

- PELI™ portable case,
- MultiCon **CMC-99** or **CMC-141** controller/data recorder,
- power cable,
- connectors (socket-plug) for sensors and communication links in the ordered amount.

Optionally:

- **DAQ Manager** Software CD Box,
- **LKS-99/141** licence key for data logging,
- **MS-4** (4 GB) or **MS-8** (8 GB) mini pendrive USB.



	CMC-99 in portable case	CMC-141 in portable case
Power supply	19V ÷ 50V DC, 16V ÷ 35V AC or 85V ÷ 260V AC/DC, 50-60 Hz	19V ÷ 50V DC, 16V ÷ 35V AC or 85V ÷ 260V AC/DC, 50-60 Hz
Inputs / outputs type	up to 23 input/output connectors: universal, analogue (0/4 ÷ 20 mA, 0/1 ÷ 5V, 0/2 ÷ 10V), thermocouple (J, K, S, T, N, R, B, E, L, ± 25 mV, ± 100 mV, -10 ÷ 25 mV, -10 ÷ 100 mV), resistance (Pt100, Pt500, Pt1000, Pt'50, Pt'100, Pt'500, Ni100, Ni500, Ni1000, Cu50, Cu100, Cu'50, Cu'100, 0 ÷ 300 Ω, 0 ÷ 3 kΩ), counter/ flowmeter/ ratemeter, digital	up to 23 input/output connectors: universal, analogue (0/4 ÷ 20 mA, 0/1 ÷ 5V, 0/2 ÷ 10V), thermocouple (J, K, S, T, N, R, B, E, L, ± 25 mV, ± 100 mV, -10 ÷ 25 mV, -10 ÷ 100 mV), resistance (Pt100, Pt500, Pt1000, Pt'50, Pt'100, Pt'500, Ni100, Ni500, Ni1000, Cu50, Cu100, Cu'50, Cu'100, 0 ÷ 300 Ω, 0 ÷ 3 kΩ), counter/ flowmeter/ ratemeter, digital
Sensor supply output	24V DC ±5% / max. 200 mA	24V DC ±5% / max. 200 mA
Communication interfaces	options: RS-485, Modbus RTU, 1200 ÷ 115200 bit/sec., Ethernet	options: RS-485, Modbus RTU, 1200 ÷ 115200 bit/sec., Ethernet
Display	TFT 3.5"; colour, graphic TFT, 320 x 240 pixels, with touchscreen	TFT 5.7"; colour, graphic TFT, 320 x 240 pixels, with touchscreen
Memory capacity	internal 1,5 GB	internal 1,5 GB
Data recording speed	from 0.1 s to 24 h with resolution 0.1 s	from 0.1 s to 24 h with resolution 0.1 s
Protection class	IP 67	IP 67
Operating temperature	0°C ÷ +50°C (optional -20°C ÷ +50°C)	0°C ÷ +50°C (optional -20°C ÷ +50°C)
Weight	2.5 kg (case 1.4 kg)	2.5 kg (case 1.4 kg)
Dimensions	portable case: 285 x 246 x 174 mm MultiCon CMC-99: 96 x 96 x 100 mm	portable case: 285 x 246 x 174 mm MultiCon CMC-141: 144 x 144 x 100 mm

SOFTWARE

DAQ Manager software is used for service of MultiCon data loggers. The software allows to visualize recorded data in the form of graphs and tables, group measurement results, create reports and export data into other files.

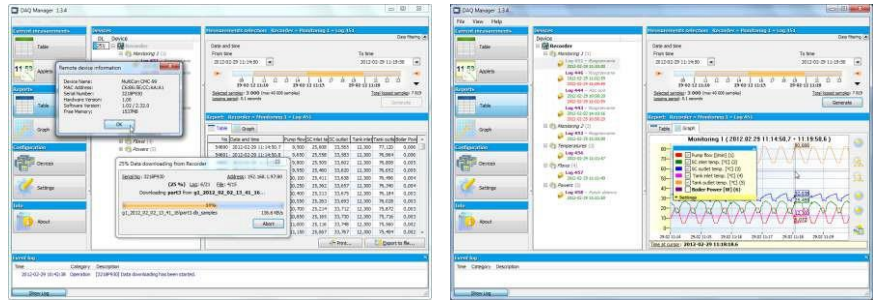

ORDERING

version: _____

P130-CMC-XXX-XX-X-X

99A: 3.5" display, case with a compartment for accessories/sensors, 11 input/output/communication connectors max., mounted on the right side of the case

99B: 3.5" display, case without a compartment for accessories/sensors, 23 input/output/communication connectors max.

141: 5.7" display, case without a compartment for accessories/sensors, 23 input/output/communication connectors max.

number of connectors: _____

- | | | |
|----|-----------------------|----------------------|
| 1 | Ethernet port: | |
| 2 | 0 : none | power supply: |
| : | 4 : RJ45 | 3 : 24V AC/DC |
| 23 | | 4 : 85V - 260V AC/DC |

* - full order code for the MultiCon CMC-99/141 should also be provided

Ordering example:
P130-CMC-99A-4-0-4 with CMC-99-PS42/E/E/E/RT4-0B1

ACCESSORIES

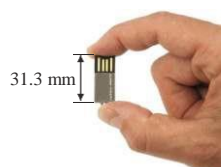

MS - USB flash drive
An incredibly small, light and stylish flash drive offering 4 or 8 GB data storage (31.3 x 12.4 mm / 6 g) has been designed with easy storage and transport in mind. It will easily fit in a P130 case with a closed upper lid.

EXAMPLARY PIN ASSIGNMENT

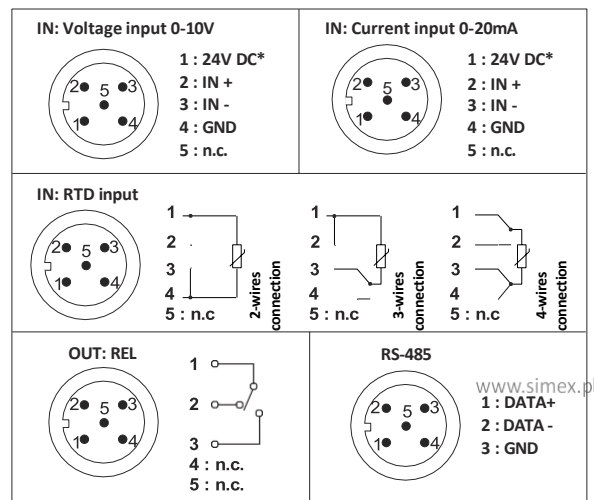
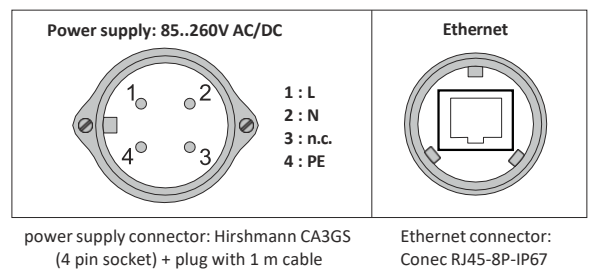

MultiLog Wn!t!fod

P130-SRD-99

- up to 11 input/output/communication connectors
- LCD 2.9" monochrome display
- USB Host port for flash data storage
- 2 electronic relay outputs optional



The portable **MultiLog SRD-99** data recorder set in a **P130** portable case is designed to record, display current or average values and present data in the form of trend graphs of various technological parameters. The set may be equipped with 1 to 8 measuring inputs: 0/4-20 mA or Pt 100/500/1000 and, optionally, 2 relay outputs. The primary function of the outputs is signalling alarm states but the configuration menu also allows to use them in a variety of control systems. Each of the outputs can be controlled by a single channel or group of measurement channels with individually adjustable thresholds. The recorder was placed in a high quality PELI™ transport case. High impact, dustproof and waterproof case housing allows to use the set virtually in any environmental conditions.

The main advantages:

- USB Host port to retrieve and store the data in flash memory,
- waterproof and dustproof case housing, designed to work in conditions of high humidity, high temperature jumps, dust, pressure differences, etc.,
- 2 MB data memory or 8 MB in the version with USB interface,
- free configuration and recording software.



ACCESSORIES

MS - USB flash drive

An incredibly small, light and stylish flash drive offering 4 or 8 GB data storage (31.3 x 12.4 mm / 6 g) has been designed with easy storage and transport in mind. It will easily fit in a P130 case with a closed upper lid.

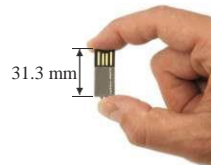

SOFTWARE



The **Loggy Soft** enables the visualization, archiving and printing of measurements (e.g. temperature, humidity, pressure) stored in MultiLog device memory.



The **S-Toolkit** enables configuration reading and writing operations, updating the device firmware and obtaining basic information on MultiLog series devices through RS-485 serial interface or flash-disk devices plugged into USB port.

MultiLog

P130-SRD-9



TECHNICAL DATA

	SRD-99 in portable case
Power supply	19V ÷ 50V DC; 16V ÷ 35V AC or 85 ÷ 260V AC/DC
Measuring inputs	up to 8 measuring inputs
Digital input	1 digital input, 10-30V DC
Measuring range	0/4-20 mA; 0/1-5V, 0/2-10V or Pt100 / Pt500 / Pt1000 (4-wires)
Outputs	2 electronic relays (ER1, ER2), 24VAC (35VDC)/200 mA
Sensor supply output	24V DC / max. 200 mA, not separated
Communication interface	RS-485, Modbus RTU, 1200 ÷ 115200 bit/sec.
Display	2.9" LCD, graphic, 128 x 64 points, with backlight
Memory capacity	2 MB in version without USB Host port 8 MB in version with USB Host port
Protection class	IP 67
Operating temperature	0°C ÷ +50°C
Weight	2.5 kg (case 1.4 kg)
Materials	body: Polypropylene latch: ABS lid O-Ring: Polymer pins: Stainless Steel
Dimensions	portable case: 285 x 246 x 174 mm MultiLog SRD-99: 96 x 96 x 100 mm

EXAMPLARY PIN ASSIGNMENT

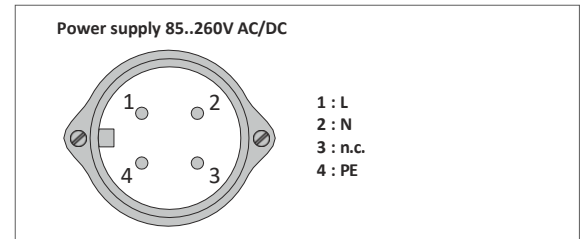

power supply connector: Hirshmann CA3GS (4 pin socket)
+ plug with 1 m cable

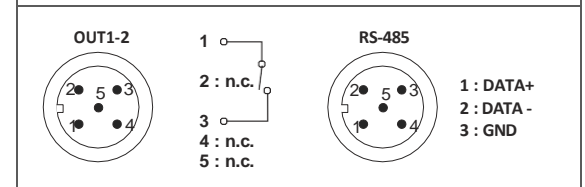
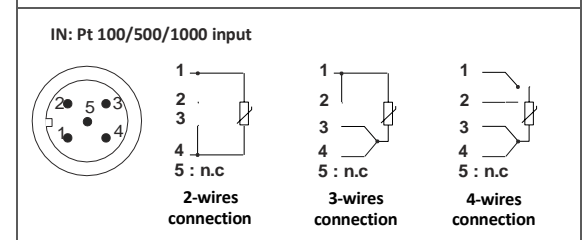
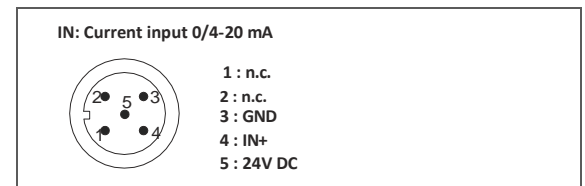

I/O connectors: Hirshmann EF12M5 (5 pin socket) + plug

SET CONTENTS

- PELI™ portable case,
- MultiLog SRD-99 data logger,
- power cable,
- connectors (socket-plug) for sensors and communication links in the ordered amount,
- compartment for accessories/sensors,
- CD-ROM with software and manuals.

Optionally:

- **SRS-2/4-Z45** (RS-232/RS-485 converter)
- **SRS-U/4-Z45** (USB/RS-485 converter)
- **MS-4** (4 GB) or **MS-8** (8 GB) mini pendrive USB.

ORDERING

P130-SRD-99-XX-0-X

number

of connectors:

1
2
:
11

power supply:

3 : 24V AC/DC
4 : 85V - 260V AC/DC

* - full order code for the MultiLog SRD-99 should also be provided

Ordering example:

P130-SRD-99-4-0-4 with SRD-99-4128-1-4-0B1

Dealer Benelux:



ADVANCED MEASURING
— INSTRUMENTS —

Zandstraat 4D B-9270 Laarne Tel: +32 9 273 52 09
www.aminstruments.be – Info@am-instruments.be